



FSDM0465RS

Green Mode Fairchild Power Switch (FPS™)

Features

- Internal Avalanche Rugged SenseFET
- Advanced Burst-Mode Operation Consumes under 1W at 240V_{AC} and 0.5W Load
- Precision Fixed Operating Frequency: 66kHz
- Internal Startup Circuit
- Improved Pulse-by-Pulse Current Limiting
- Over-Voltage Protection (OVP)
- Overload Protection (OLP)
- Internal Thermal Shutdown Function (TSD)
- Abnormal Over-Current Protection (AOCP)
- Auto-Restart Mode
- Under-Voltage Lock Out (UVLO) with Hysteresis
- Low Operating Current: 2.5mA
- Built-in Soft-Start

Description

The FSDM0465RS is an integrated Pulse-Width Modulator (PWM) and SenseFET specifically designed for high-performance offline Switch Mode Power Supplies (SMPS) with minimal external components. The device is an integrated, high-voltage, power-switching regulator that combines an avalanche rugged SenseFET with a current mode PWM control block. The PWM controller includes integrated fixed-frequency oscillator, under-voltage lockout, leading-edge blanking (LEB), optimized gate driver, internal soft-start, temperature-compensated precise-current sources for a loop compensation and self-protection circuitry. Compared with a discrete MOSFET and PWM controller solution, it reduces total cost, component count, size and weight; while increasing efficiency, productivity and system reliability. This device is a basic platform well suited for cost effective designs of flyback converters.

Applications

- SMPS for LCD Monitor and STB
- Adaptor

SKYTECH
ELECTRONIC

Ordering Information

Product Number	Package	 Eco Status	Marking Code	BV _{DSS}	R _{DS(ON)} Max.
FSDM0465RSWDTU ⁽¹⁾	TO-220F-6L(Forming)	RoHS	DM0465RS	650V	2.6Ω

Note:

1. WDTU: Forming Type.



For Fairchild's definition of "green" Eco Status, please visit: http://www.fairchildsemi.com/company/green/rohs_green.html.

FPS™ is a trademark of Fairchild Semiconductor Corporation.

Internal Block Diagram

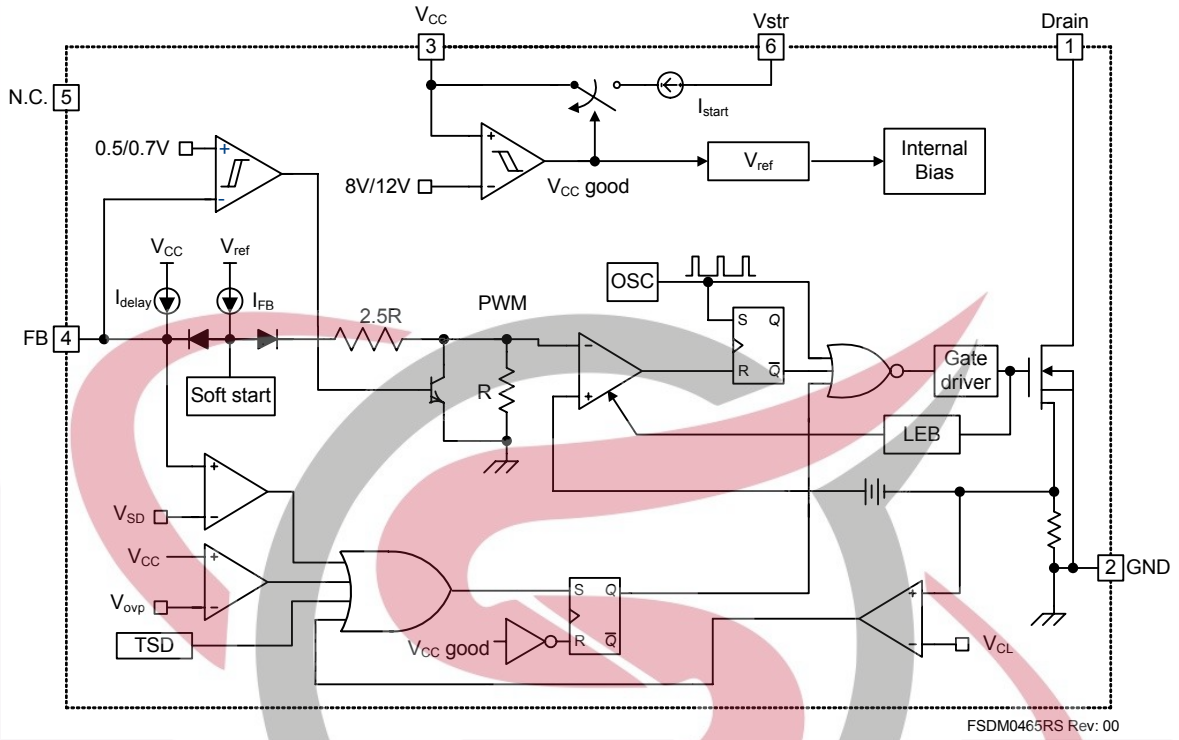
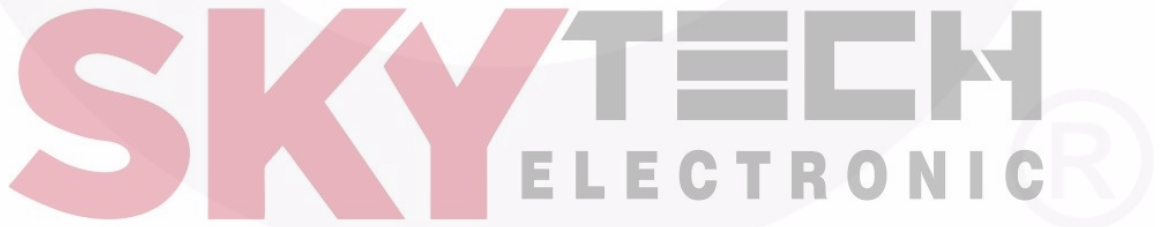

Figure 2. Functional Block Diagram



Pin Configuration

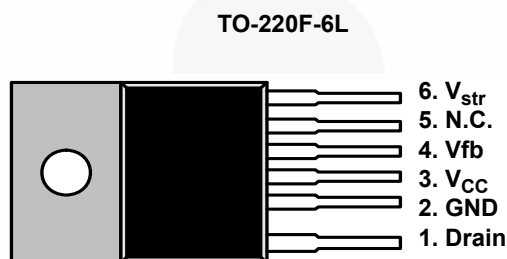
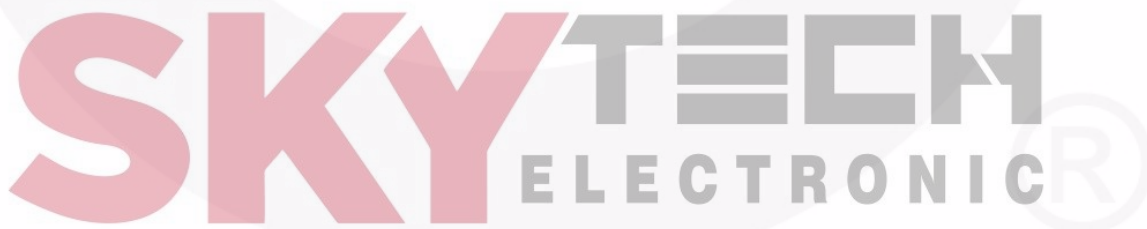

Figure 3. Pin Configuration (Top View)

Pin Definitions

Pin #	Name	Description
1	Drain	SenseFET drain. High-voltage power SenseFET drain connection.
2	GND	Ground. This pin is the control ground and the SenseFET source.
3	V_{CC}	Power Supply. This pin is the positive supply input, providing internal operating current for both startup and steady-state operation.
4	V_{fb}	Feedback. This pin is internally connected to the inverting input of the PWM comparator. The collector of an opto-coupler is typically tied to this pin. For stable operation, a capacitor should be placed between this pin and GND. If the voltage of this pin reaches 6V, the overload protection triggers, which shuts down the FPS.
5	N.C.	No Connection.
6	V_{str}	Startup. This pin is connected directly, or through a resistor, to the high-voltage DC link. At startup, the internal high-voltage current source supplies internal bias and charges the external capacitor connected to the V_{CC} pin. Once V_{CC} reaches 12V, the internal current source is disabled. It is not recommended to connect V_{str} and Drain together.



Absolute Maximum Ratings

Stresses exceeding the absolute maximum ratings may damage the device. The device may not function or be operable above the recommended operating conditions and stressing the parts to these levels is not recommended. In addition, extended exposure to stresses above the recommended operating conditions may affect device reliability. The absolute maximum ratings are stress ratings only. $T_A = 25^\circ\text{C}$, unless otherwise specified.

Symbol	Parameter	Value	Unit
BV_{DSS}	Drain Source Breakdown Voltage	650	V
V_{STR}	V_{STR} Maximum Voltage	650	V
I_{DM}	Drain Current Pulsed ⁽⁶⁾	$T_C=25^\circ\text{C}$ 9.6	A_{DC}
I_D	Continuous Drain Current ⁽⁷⁾	$T_C=25^\circ\text{C}$ 2.2	A_{RMS}
		$T_C=100^\circ\text{C}$ 1.4	A_{RMS}
E_{AS}	Single Pulsed Avalanche Energy ⁽⁸⁾	120	mJ
V_{CC}	Supply Voltage	20	V
V_{FB}	Input Voltage Range	-0.3 to 12	V
P_D (Watt H/S)	Total Power Dissipation ($T_C=25^\circ\text{C}$)	45	W
T_J	Operating Junction Temperature	Internally limited	$^\circ\text{C}$
T_A	Operating Ambient Temperature	-25 to +85	$^\circ\text{C}$
T_{STG}	Storage Temperature	-55 to +150	$^\circ\text{C}$
ESD	ESD Capability, Human Body Model, JESD22-A114 (All pins excepts for V_{STR} and V_{FB})	2.0 ($GND-V_{STR}/V_{FB}=1.5\text{kV}$)	kV
	ESD Capability, Charged Device Model, JESD22-C101	1.0	kV

Notes:

6. Repetitive rating: pulse width limited by maximum junction temperature.
7. This value is RMS current rating which should not be confused by the switching current.
8. $L=14\text{mH}$, starting $T_J=25^\circ\text{C}$.

Thermal Impedance

$T_A=25^\circ\text{C}$, unless otherwise specified.

Symbol	Parameter	Value	Unit
θ_{JA} ⁽⁹⁾	Junction-to-Ambient Thermal	50	$^\circ\text{C}/\text{W}$
θ_{JC} ⁽¹⁰⁾	Junction-to-Case Thermal	2.78	$^\circ\text{C}/\text{W}$

Notes:

9. Free standing with no heat-sink under natural convection.
10. Infinite cooling condition - Refer to the SEMI G30-88.

Electrical Characteristics

T_A = 25°C unless otherwise specified.

Symbol	Parameter	Condition	Min.	Typ.	Max.	Unit
SenseFET SECTION						
I _{DSS}	Zero Gate Voltage Drain Current	V _{DS} = 650V, V _{GS} = 0V			250	μA
		V _{DS} = 520V, V _{GS} = 0V, T _C = 125°C			250	μA
R _{DS(ON)}	Static Drain Source on Resistance ⁽¹¹⁾	V _{GS} = 10V, I _D = 2.5A		2.2	2.6	Ω
C _{OSS}	Output Capacitance	V _{GS} = 0V, V _{DS} = 25V, f = 1MHz		60		pF
t _{d(on)}	Turn-On Delay Time	V _{DD} = 325V, I _D = 5A		23		ns
t _r	Rise Time			20		
t _{d(off)}	Turn-Off Delay Time			65		
t _f	Fall Time			27		
CONTROL SECTION						
f _{OSC}	Switching Frequency	V _{FB} = 3V	60	66	72	kHz
Δf _{STABLE}	Switching Frequency Stability	13V ≤ V _{CC} ≤ 18V	0	1	3	%
Δf _{OSC}	Switching Frequency Variation ⁽¹²⁾	-25°C ≤ T _A ≤ 85°C	0	±5	±10	%
I _{FB}	Feedback Source Current	V _{FB} = GND	0.7	0.9	1.1	mA
D _{MAX}	Maximum Duty Cycle		77	82	87	%
D _{MIN}	Minimum Duty Cycle				0	%
V _{START}	UVLO Threshold Voltage	V _{FB} = GND	11	12	13	V
V _{STOP}		V _{FB} = GND	7	8	9	V
t _{S/S}	Internal Soft-Start Time	V _{FB} = 3V		10	15	ms
BURST MODE SECTION						
V _{BURH}	Burst Mode Voltages	V _{CC} = 14V		0.7		V
V _{BURL}		V _{CC} = 14V		0.5		V
PROTECTION SECTION						
V _{SD}	Shutdown Feedback Voltage	V _{FB} ≥ 5.5V	5.5	6.0	6.5	V
I _{DELAY}	Shutdown Delay Current	V _{FB} = 5V	2.8	3.5	4.2	μA
t _{LEB}	Leading Edge Blanking Time ⁽¹²⁾			250		ns
I _{LIMIT}	Peak Current Limit ⁽¹³⁾	V _{FB} = 5V, V _{CC} = 14V	1.6	1.8	2.0	A
V _{OVP}	Over-Voltage Protection		18	19	20	V
T _{SD}	Thermal Shutdown Temperature ⁽¹²⁾		+130	+145	+160	°C
TOTAL DEVICE SECTION						
I _{START}	Operating Supply Current ⁽¹⁴⁾	V _{FB} = GND, V _{CC} = 11V		1.0	1.3	mA
I _{OP}	Operating Supply Current ⁽¹⁴⁾	V _{FB} = GND, V _{CC} = 14V		2.5	5.0	mA
I _{OP(MIN)}		V _{FB} = GND, V _{CC} = 10V				
I _{OP(MAX)}		V _{FB} = GND, V _{CC} = 18V				

Notes:

11. Pulse test: Pulse width ≤ 300μs, duty ≤ 2%.
12. These parameters, although guaranteed at the design, are not tested in mass production.
13. These parameters indicate the inductor current.
14. This parameter is the current flowing into the control IC.

Comparison Between FS6M07652RTC and FSDM0465RS

Function	FS6M07652RTC	FSDM0465RS	FSDM0465RS Advantages
Soft-Start	Adjustable soft-start time using an external capacitor	Internal soft-start with typically 10ms (fixed)	<ul style="list-style-type: none"> ■ Gradually increasing current limit during soft-start further reduces peak current and voltage component stresses ■ Eliminates external components used for soft-start in most applications ■ Reduces or eliminates output overshoot
Burst Mode Operation	<ul style="list-style-type: none"> ■ Built into controller ■ Output voltage drops to around half 	<ul style="list-style-type: none"> ■ Built into controller ■ Output voltage fixed 	<ul style="list-style-type: none"> ■ Improve light-load efficiency ■ Reduces no-load consumption



SKYTECH
ELECTRONIC®

Typical Performance Characteristics

Graphs are normalized at $T_A = 25^\circ\text{C}$.

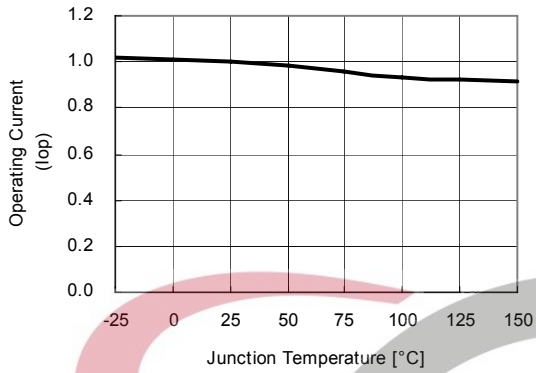

Figure 4. Operating Current vs. Temperature

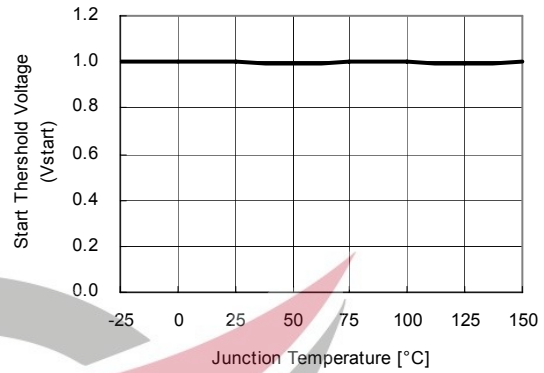

Figure 5. Start Threshold Voltage vs. Temperature

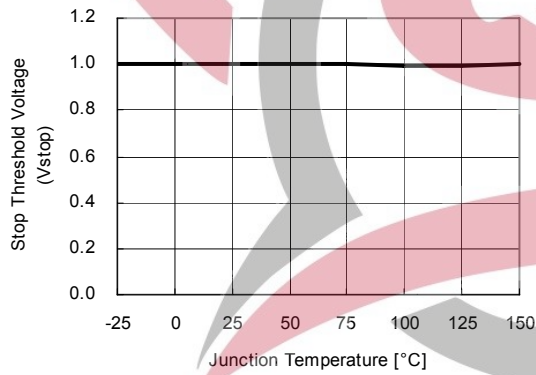

Figure 6. Stop Threshold Voltage vs. Temperature

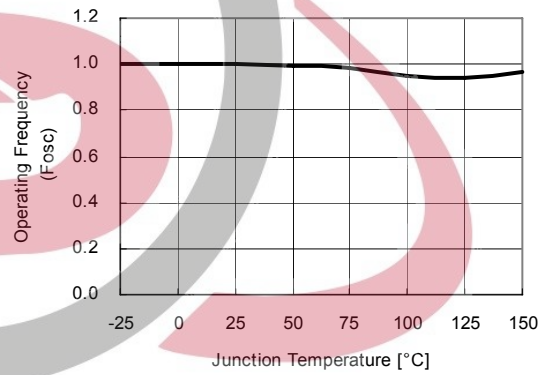

Figure 7. Operating Frequency vs. Temperature

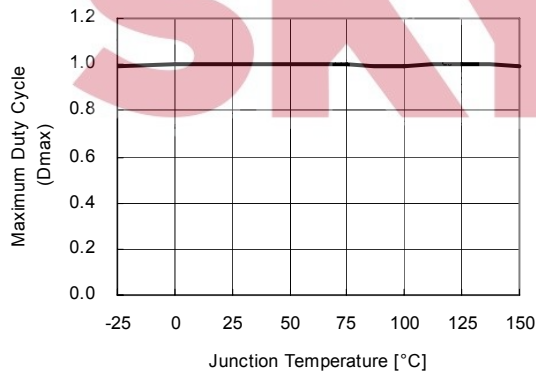

Figure 8. Maximum Duty vs. Temperature

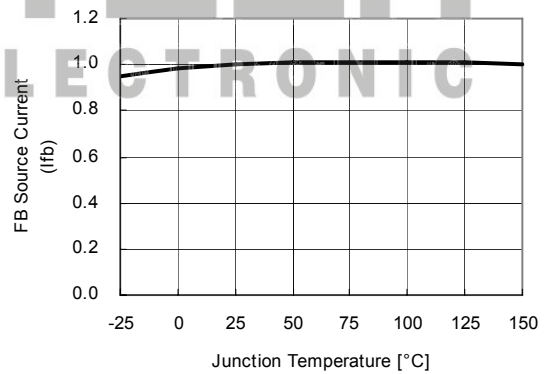

Figure 9. Feedback Source Current vs. Temperature

Typical Performance Characteristics (Continued)

Graphs are normalized at $T_A = 25^\circ\text{C}$.

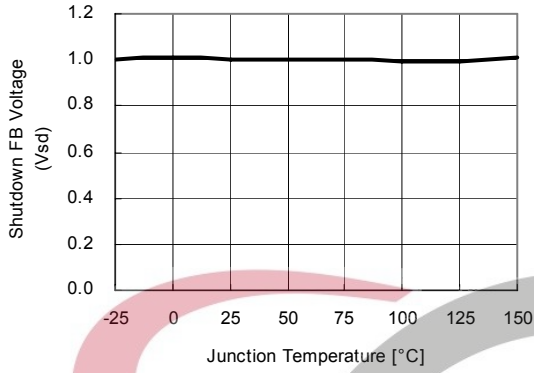

Figure 10. Shutdown Feedback Voltage vs. Temperature

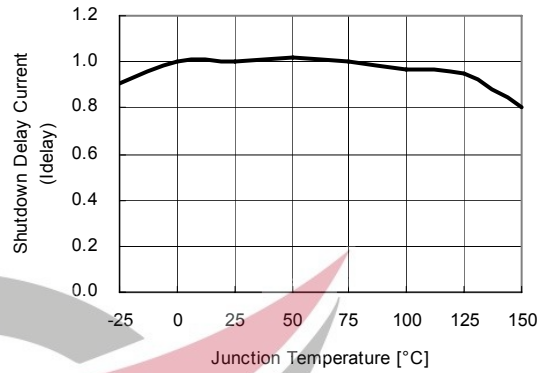

Figure 11. Shutdown Delay Current vs. Temperature

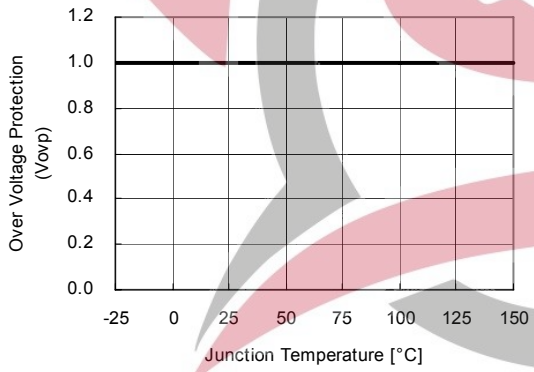

Figure 12. Over-Voltage Protection vs. Temperature

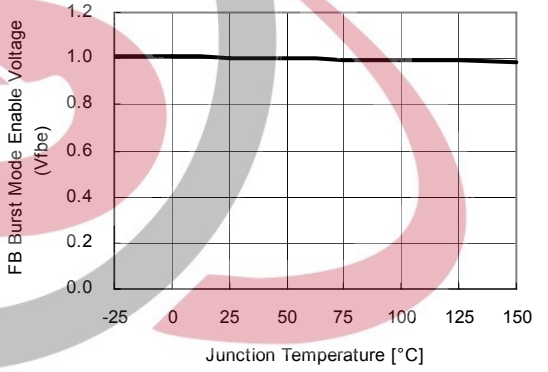

Figure 13. Burst Mode Enable Voltage vs. Temperature

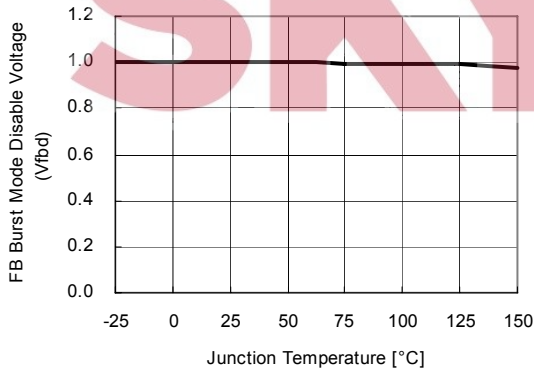

Figure 14. Burst Mode Disable Voltage vs. Temperature

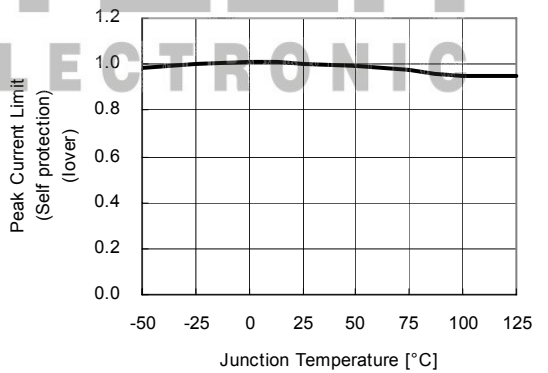

Figure 15. Current Limit vs. Temperature

Typical Performance Characteristics (Continued)

Graphs are normalized at $T_A = 25^\circ\text{C}$.

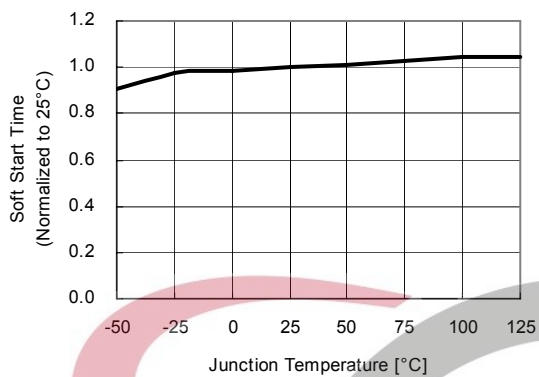
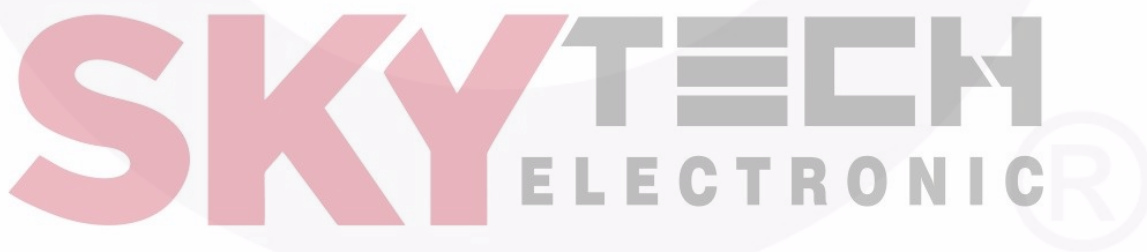

Figure 16. Soft-Start Time vs. Temperature



disable the switching of the power SenseFET until the fault condition is eliminated (see Figure 19).

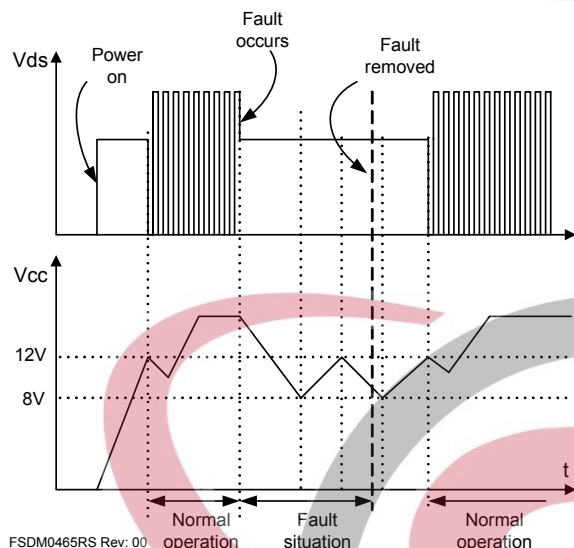

Figure 19. Auto Restart Operation

3.1 Overload Protection (OLP): Overload is defined as the load current exceeding a pre-set level due to an unexpected event. In this situation, the protection circuit should be activated to protect the SMPS. However, even when the SMPS is in the normal operation, the overload protection circuit can be activated during the load transition. To avoid this undesired operation, the overload protection circuit is designed to be activated after a specified time to determine whether it is a transient situation or an overload situation. Because of the pulse-by-pulse current limit capability, the maximum peak current through the SenseFET is limited, and therefore the maximum input power is restricted with a given input voltage. If the output consumes beyond this maximum power, the output voltage (V_O) decreases below the set voltage. This reduces the current through the opto-coupler LED, which reduces the opto-coupler transistor current, thus increasing the feedback voltage (V_{FB}). If V_{FB} exceeds 2.5V, D1 is blocked and the 3.5 μ A current source starts to charge C_B slowly up to V_{CC} . In this condition, V_{FB} continues increasing until it reaches 6V, when the switching operation is terminated as shown in Figure 20. The delay time for shutdown is the time required to charge C_B from 2.5V to 6.0V with 3.5 μ A. In general, a 10 ~ 50ms delay time is typical for most applications.

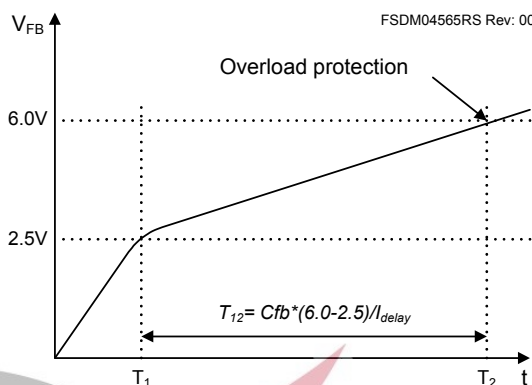

Figure 20. Overload Protection

3.2 Over-Voltage Protection (OVP): If the secondary side feedback circuit were to malfunction or a solder defect caused an open in the feedback path, the current through the opto-coupler transistor becomes almost zero. Then, V_{FB} climbs up in a similar manner to the overload situation, forcing the preset maximum current to be supplied to the SMPS until the overload protection is activated. Because more energy than required is provided to the output, the output voltage may exceed the rated voltage before the overload protection is activated, resulting in the breakdown of the devices in the secondary side. To prevent this situation, an over-voltage protection (OVP) circuit is employed. In general, V_{CC} is proportional to the output voltage and the FSDM0465RS uses V_{CC} instead of directly monitoring the output voltage. If V_{CC} exceeds 19V, an OVP circuit is activated resulting in the termination of the switching operation. To avoid undesired activation of OVP during normal operation, V_{CC} should be designed to be below 19V.

3.3 Thermal Shutdown (TSD): The SenseFET and the control IC are built in one package. This makes it easy for the control IC to detect the heat generation from the SenseFET. When the temperature exceeds approximately 150°C, the thermal shutdown is activated.

4.2 Abnormal Over-Current Protection (AOCP): When the secondary rectifier diodes or the transformer pins are shorted, a steep current with extremely high di/dt can flow through the SenseFET during the LEB time. Even though the FPS has overload protection, it is not enough to protect the FPS in those abnormal cases, since severe current stress is imposed on the SenseFET until OLP triggers. This IC has an internal AOCP circuit shown in Figure 21. When the gate turn-on signal is applied to the power SenseFET, the AOCP block is enabled and monitors the current through the sensing resistor. The voltage across the resistor is compared with a preset AOCP level. If the sensing resistor voltage is

greater than the AOCP level, the set signal is applied to the latch, resulting in the shutdown of the SMPS.

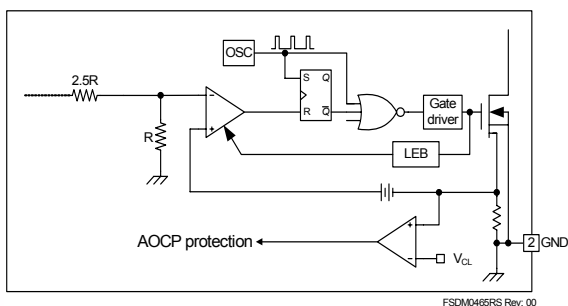

Figure 21. Abnormal Over-Current Protection

4. Soft-Start: The FSDM0465RS has an internal soft-start circuit that increases PWM comparator inverting input voltage together with the SenseFET current slowly after it starts up. The typical soft-start time is 10ms. The pulse width to the power switching device is progressively increased to establish the correct working conditions for transformers, inductors, and capacitors. The voltage on the output capacitors is progressively increased with the intention of smoothly establishing the required output voltage. It helps prevent transformer saturation and reduces the stress on the secondary diode during startup.

5. Burst Operation: To minimize power dissipation in standby mode, the FSDM0465RS enters burst mode operation. As the load decreases, the feedback voltage decreases. As shown in Figure 22, the device automatically enters burst mode when the feedback voltage drops below V_{BURL} (500mV). At this point switching stops and the output voltages start to drop at a rate dependent on standby current load. This causes the feedback voltage to rise. Once it passes V_{BURH} (700mV) switching resumes. The feedback voltage then falls and the process repeats. Burst mode operation alternately enables and disables switching of the power SenseFET thereby reducing switching loss in standby mode.

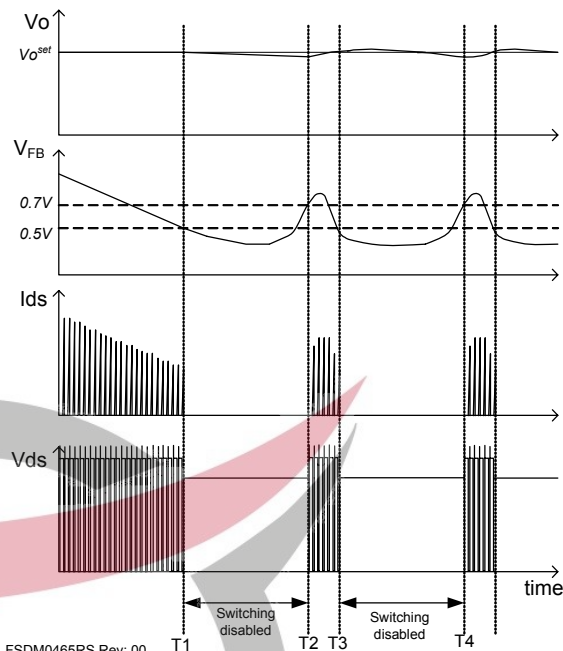

Figure 22. Waveforms of Burst Operation



Typical Application Circuit

Application	Output Power	Input Voltage	Output Voltage (Maximum Current)
LCD Monitor	34W	Universal Input (85-265V _{AC})	5V (2.0A) 12V (2.0A)

Features

- High Efficiency (>81% at 85V_{AC} Input)
- Low Zero Load Power Consumption (<300mW at 240V_{AC} Input)
- Low Standby Mode Power Consumption (<800mW at 240V_{AC} Input and 0.3W Load)
- Low Component Count
- Enhanced System Reliability through Various Protection Functions
- Internal Soft-Start (10ms)

Key Design Notes

- Resistors R102 and R105 are employed to prevent startup at low input voltage. After startup, there is no power loss in these resistors since the startup pin is internally disconnected after startup.
- The delay time for overload protection is designed to be about 50ms with C106 of 47nF. If a faster triggering of OLP is required, C106 can be reduced to 10nF.
- Zener diode ZD102 is used for a safety test such as UL. When the drain pin and feedback pin are shorted, the zener diode fails and remains short, which causes the fuse (F1) blown and prevents explosion of the opto-coupler (IC301). This zener diode also increases the immunity against line surge.

1. Schematic

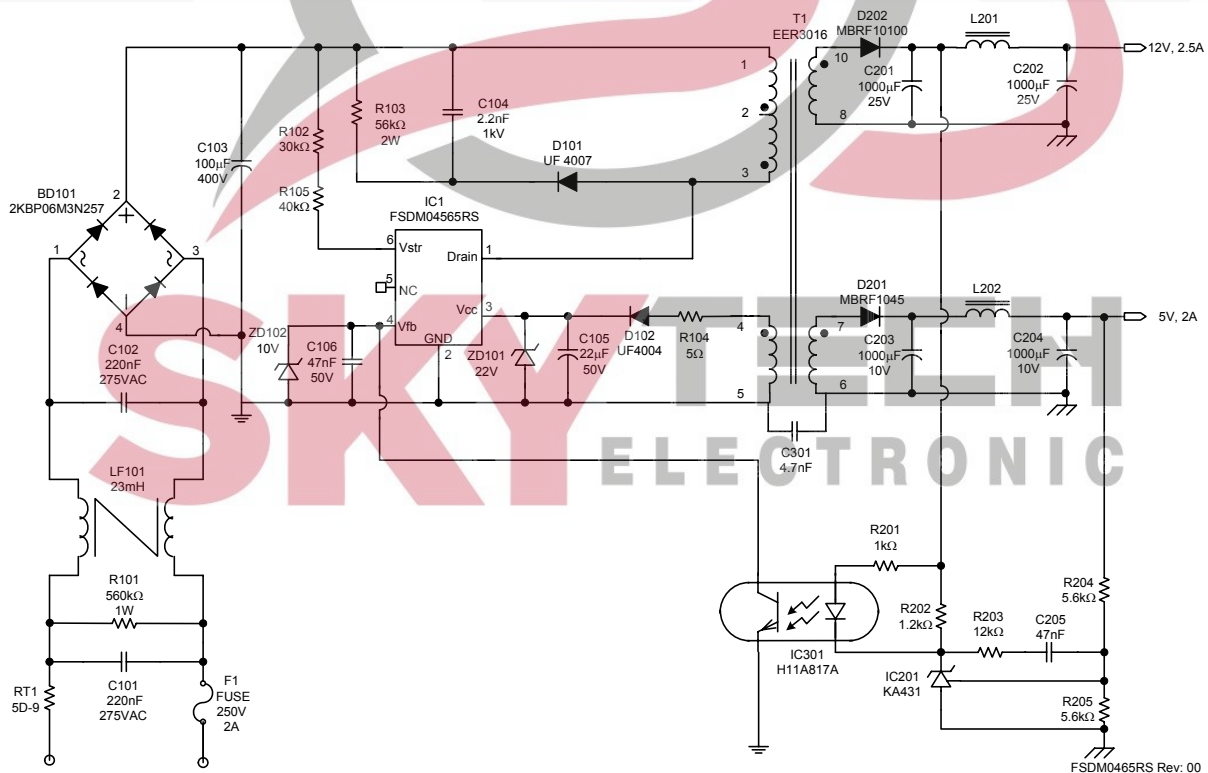

Figure 23. Demo Circuit

2. Transformer

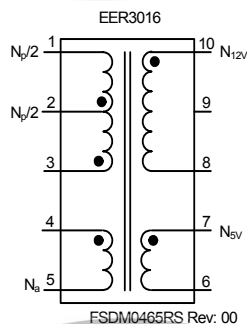

Figure 24. Transformer Schematic Diagram

3. Winding Specification

No	Pin (s→f)	Wire	Turns	Winding Method
Na	4 → 5	0.2 ^φ × 1	8	Center Winding
Insulation: Polyester Tape t = 0.050mm, 2 Layers				
Np/2	2 → 1	0.4 ^φ × 1	18	Solenoid Winding
Insulation: Polyester Tape t = 0.050mm, 2 Layers				
N _{12V}	10 → 8	0.3 ^φ × 3	7	Center Winding
Insulation: Polyester Tape t = 0.050mm, 2 Layers				
N _{5V}	7 → 6	0.3 ^φ × 3	3	Center Winding
Insulation: Polyester Tape t = 0.050mm, 2 Layers				
Np/2	3 → 2	0.4 ^φ × 1	18	Solenoid Winding
Outer Insulation: Polyester Tape t = 0.050mm, 2 Layers				

4. Electrical Characteristics

	Pin	Specification	Remarks
Inductance	1 - 3	650μH ± 10%	100kHz, 1V
Leakage Inductance	1 - 3	10μH Maximum	2 nd all short

5. Core & Bobbin

- Core: EER 3016
- Bobbin: EER3016
- Ae(mm²): 96

6. Demo Circuit Part List

Part	Value	Note	Part	Value	Note
Fuse			Inductor		
F101	2A/250V		L201	5μH	Wire 1.2mm
NTC			L202	5μH	Wire 1.2mm
RT101	5D-9		Diode		
Resistor			D101	UF4007	
R101	560kΩ	1W	D102	UF4004	
R102	30kΩ	1/4W	D201	MBRF1045	
R103	56kΩ	2W	D202	MBRF10100	
R104	5Ω	1/4W	ZD101	Zener Diode	22V
R105	40kΩ	1/4W	ZD102	Zener Diode	10V
R201	1kΩ	1/4W	Bridge Diode		
R202	1.2kΩ	1/4W	BD101	2KBP06M 3N257	Bridge Diode
R203	12kΩ	1/4W			
R204	5.6kΩ	1/4W	Line Filter		
R205	5.6kΩ	1/4W	LF101	23mH	Wire 0.4mm
			IC		
Capacitor			IC101	FSDM0465RS	FPS™
C101	220nF/275V _{AC}	Box Capacitor	IC201	KA431 (TL431)	Voltage Reference
C102	220nF/275V _{AC}	Box Capacitor	IC301	H11A817A	Opto-coupler
C103	100μF/400V	Electrolytic Capacitor			
C104	2.2nF/1kV	Ceramic Capacitor			
C105	22μF/50V	Electrolytic Capacitor			
C106	47nF/50V	Ceramic Capacitor			
C201	1000μF/25V	Electrolytic Capacitor			
C202	1000μF/25V	Electrolytic Capacitor			
C203	1000μF/10V	Electrolytic Capacitor			
C204	1000μF/10V	Electrolytic Capacitor			
C205	47nF/50V	Ceramic Capacitor			
C301	4.7nF	Polyester Film Capacitor			

7. Layout

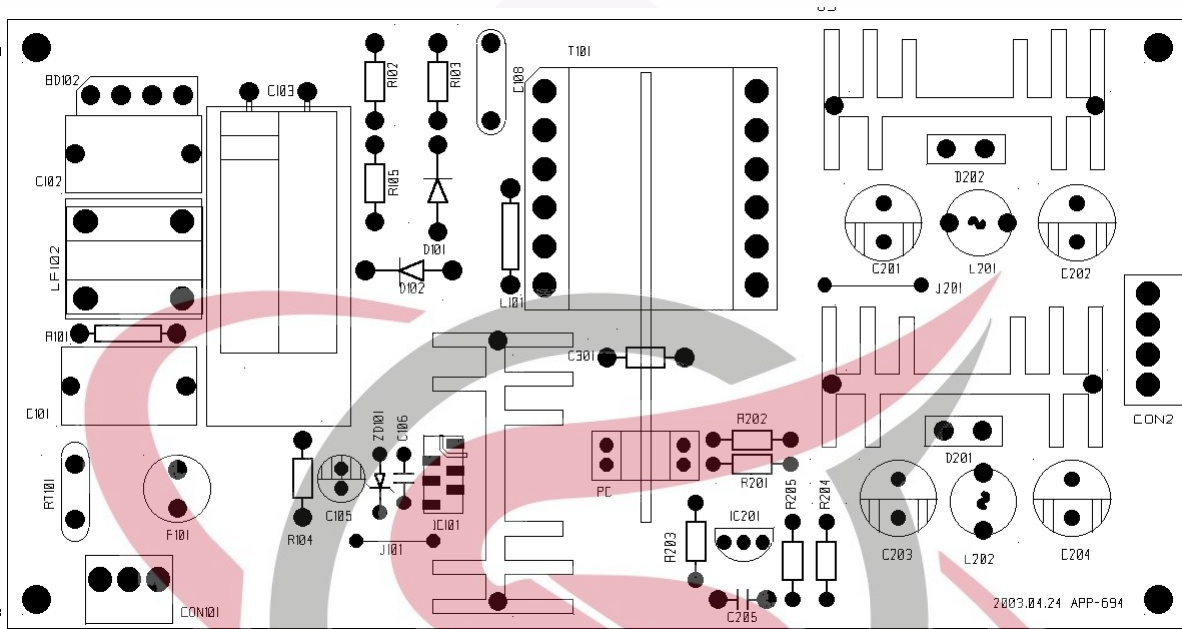

Figure 25. FSDM0465RS Demo Board (Top View)

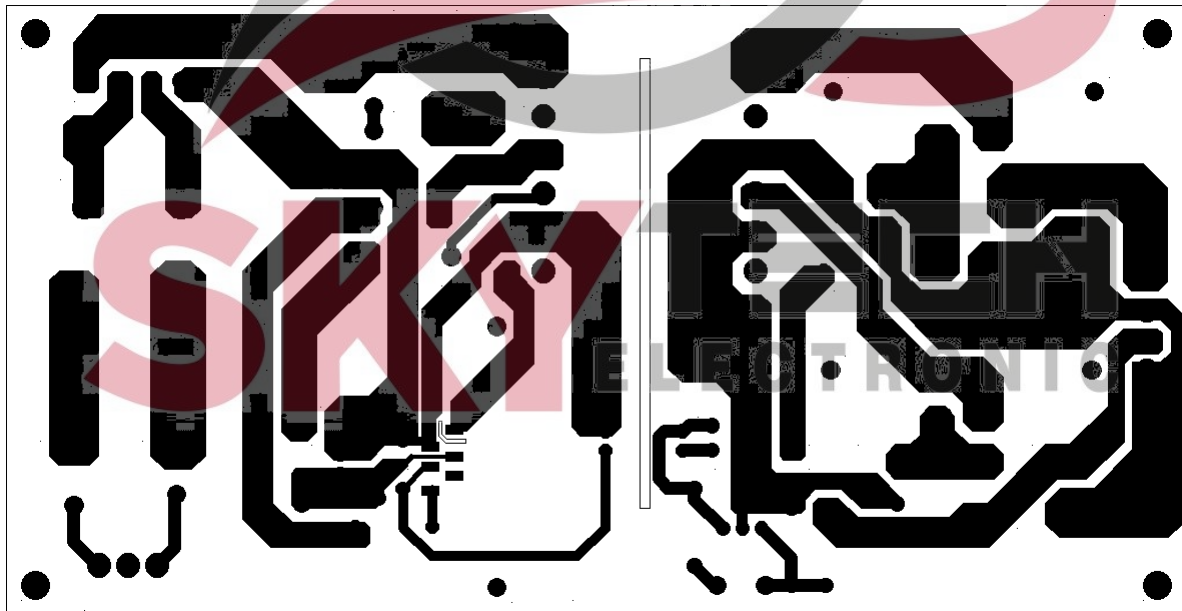



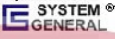

Figure 26. FSDM0465RS Demo Board (Bottom View)



TRADEMARKS

The following includes registered and unregistered trademarks and service marks, owned by Fairchild Semiconductor and/or its global subsidiaries, and is not intended to be an exhaustive list of all such trademarks.

- | | | | |
|---|--------------------------|---|---|
| Auto-SPM™ | F-PFST™ | PowerTrench® | The Power Franchise® |
| Build it Now™ | FRFET® | PowerXS™ | the power franchise |
| CorePLUS™ | Global Power Resource SM | Programmable Active Droop™ | TinyBoost™ |
| CorePOWER™ | Green FPS™ | QFET® | Q5™ |
| CROSSVOLT™ | Green FPS™ e-Series™ | Q5™ | TinyBuck™ |
| CTL™ | Gmax™ | Quiet Series™ | TinyLogic® |
| Current Transfer Logic™ | GTO™ | RapidConfigure™ | TINYOPTO™ |
| EcoSPARK® | IntelliMAX™ |  ™ | TinyPower™ |
| EfficientMax™ | ISOPLANAR™ | Saving our world, 1mW/W/kW at a time™ | TinyPWM™ |
| EZSWITCH™ | MegaBuck™ | SmartMax™ | TinyWire™ |
|  ™ | MICROCOUPLER™ | SMART START™ | TriFault Detect™ |
|  ™ | MicroFET™ | SPM® | TRUECURRENT™ |
| Fairchild® | MicroPak™ | STEALTH™ | µSerDes™ |
| Fairchild Semiconductor® | MillerDrive™ | SuperFET™ |  ™ |
| FACT Quiet Series™ | MotionMax™ | SuperSOT™.3 | UHC® |
| FACT® | Motion-SPM™ | SuperSOT™.6 | Ultra FRFET™ |
| FAST® | OPTOLOGIC® | SuperSOT™.8 | UniFET™ |
| FastvCore™ | OPTOPLANAR® | SupreMOS™ | VCX™ |
| FETBench™ | PDP SPM™ | SyncFET™ | VisualMax™ |
| FlashWriter® | Power-SPM™ | Sync-Lock™ | XST™ |
| FPS™ | |  | |

* Trademarks of System General Corporation, used under license by Fairchild Semiconductor.

DISCLAIMER

FAIRCHILD SEMICONDUCTOR RESERVES THE RIGHT TO MAKE CHANGES WITHOUT FURTHER NOTICE TO ANY PRODUCTS HEREIN TO IMPROVE RELIABILITY, FUNCTION, OR DESIGN. FAIRCHILD DOES NOT ASSUME ANY LIABILITY ARISING OUT OF THE APPLICATION OR USE OF ANY PRODUCT OR CIRCUIT DESCRIBED HEREIN; NEITHER DOES IT CONVEY ANY LICENSE UNDER ITS PATENT RIGHTS, NOR THE RIGHTS OF OTHERS. THESE SPECIFICATIONS DO NOT EXPAND THE TERMS OF FAIRCHILD'S WORLDWIDE TERMS AND CONDITIONS, SPECIFICALLY THE WARRANTY THEREIN, WHICH COVERS THESE PRODUCTS.

LIFE SUPPORT POLICY

FAIRCHILD'S PRODUCTS ARE NOT AUTHORIZED FOR USE AS CRITICAL COMPONENTS IN LIFE SUPPORT DEVICES OR SYSTEMS WITHOUT THE EXPRESS WRITTEN APPROVAL OF FAIRCHILD SEMICONDUCTOR CORPORATION.

As used herein:

1. Life support devices or systems are devices or systems which, (a) are intended for surgical implant into the body or (b) support or sustain life, and (c) whose failure to perform when properly used in accordance with instructions for use provided in the labeling, can be reasonably expected to result in a significant injury of the user.
2. A critical component in any component of a life support, device, or system whose failure to perform can be reasonably expected to cause the failure of the life support device or system, or to affect its safety or effectiveness.

ANTI-COUNTERFEITING POLICY

Fairchild Semiconductor Corporation's Anti-Counterfeiting Policy. Fairchild's Anti-Counterfeiting Policy is also stated on our external website, www.fairchildsemi.com, under Sales Support.

Counterfeiting of semiconductor parts is a growing problem in the industry. All manufacturers of semiconductor products are experiencing counterfeiting of their parts. Customers who inadvertently purchase counterfeit parts experience many problems such as loss of brand reputation, substandard performance, failed applications, and increased cost of production and manufacturing delays. Fairchild is taking strong measures to protect ourselves and our customers from the proliferation of counterfeit parts. Fairchild strongly encourages customers to purchase Fairchild parts either directly from Fairchild or from Authorized Fairchild Distributors who are listed by country on our web page cited above. Products customers buy either from Fairchild directly or from Authorized Fairchild Distributors are genuine parts, have full traceability, meet Fairchild's quality standards for handling and storage and provide access to Fairchild's full range of up-to-date technical and product information. Fairchild and our Authorized Distributors will stand behind all warranties and will appropriately address any warranty issues that may arise. Fairchild will not provide any warranty coverage or other assistance for parts bought from Unauthorized Sources. Fairchild is committed to combat this global problem and encourage our customers to do their part in stopping this practice by buying direct or from authorized distributors.

PRODUCT STATUS DEFINITIONS

Definition of Terms

Datasheet Identification	Product Status	Definition
Advance Information	Formative / In Design	Datasheet contains the design specifications for product development. Specifications may change in any manner without notice.
Preliminary	First Production	Datasheet contains preliminary data; supplementary data will be published at a later date. Fairchild Semiconductor reserves the right to make changes at any time without notice to improve design.
No Identification Needed	Full Production	Datasheet contains final specifications. Fairchild Semiconductor reserves the right to make changes at any time without notice to improve the design.
Obsolete	Not In Production	Datasheet contains specifications on a product that is discontinued by Fairchild Semiconductor. The datasheet is for reference information only.

Rev. 140

Mouser Electronics

Authorized Distributor

Click to View Pricing, Inventory, Delivery & Lifecycle Information:

[ON Semiconductor:](#)

[FSDM0465RSWDTU](#)

